

SPECIFICATIONS

Rated thermal input	13 kW
Efficiency	84 %
Smoke flue diameter	200 mm
Min. thrust (under pressure) for rated thermal input	12 Pa
Fuel gas temperature	235 °C
Volume of fuel gas	10,2 g/s
CO emissions in fuel gas (at 13 % O ₂)	0,0877 %
Dust in the fuel gas (at 13 % O ₂)	11 mg/Nm ³
Volume of fuel per hour	3,6 kg/h
Fuel	wood (beech logs)
Weight	287 kg



LIST OF SPARE PARTS

Glass



850 x 430 x 468 mm

Carcon stones

1. Front bottom
2. Back bottom
3. Back
4. Side
5. Deflector
6. Carcon blend

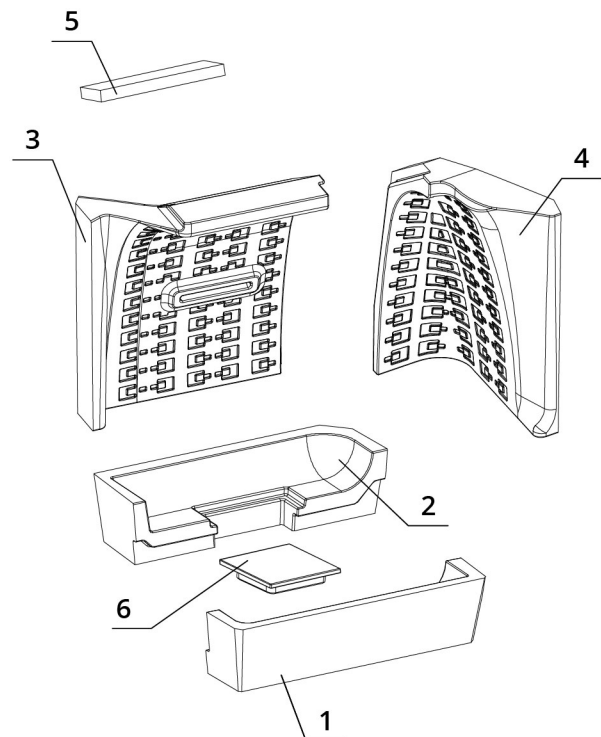

BEF THERM V 10 CL

BlmSchV
Stufe 2

15a
B-VG

ČSN EN
13229

eco
design

www.befhome.com

TECHNICAL DRAWING

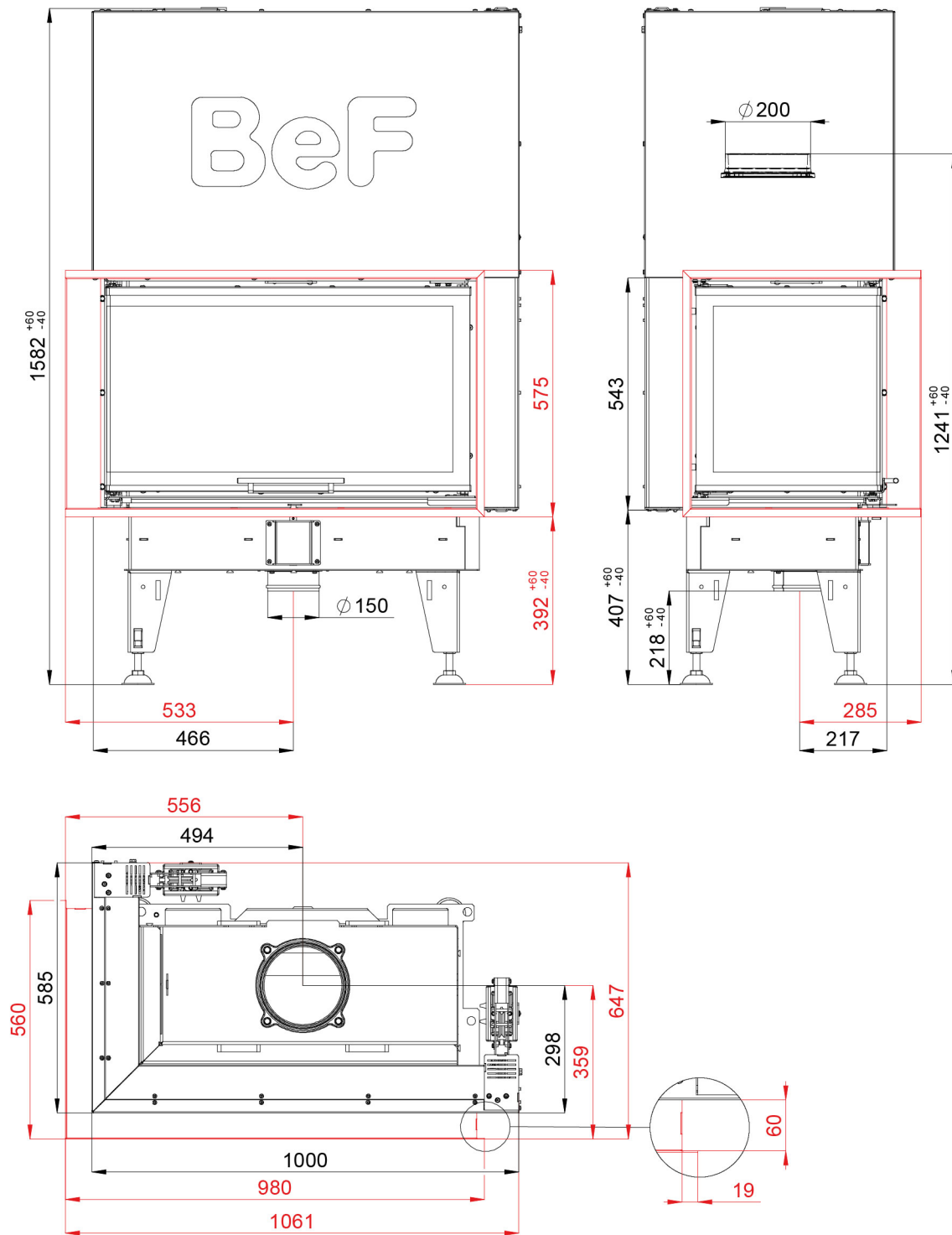

BEF THERM V 10 CL

BlmSchV
Stufe 2

15a
B-VG

ČSN EN
13229

eco
design